

# AL-KO

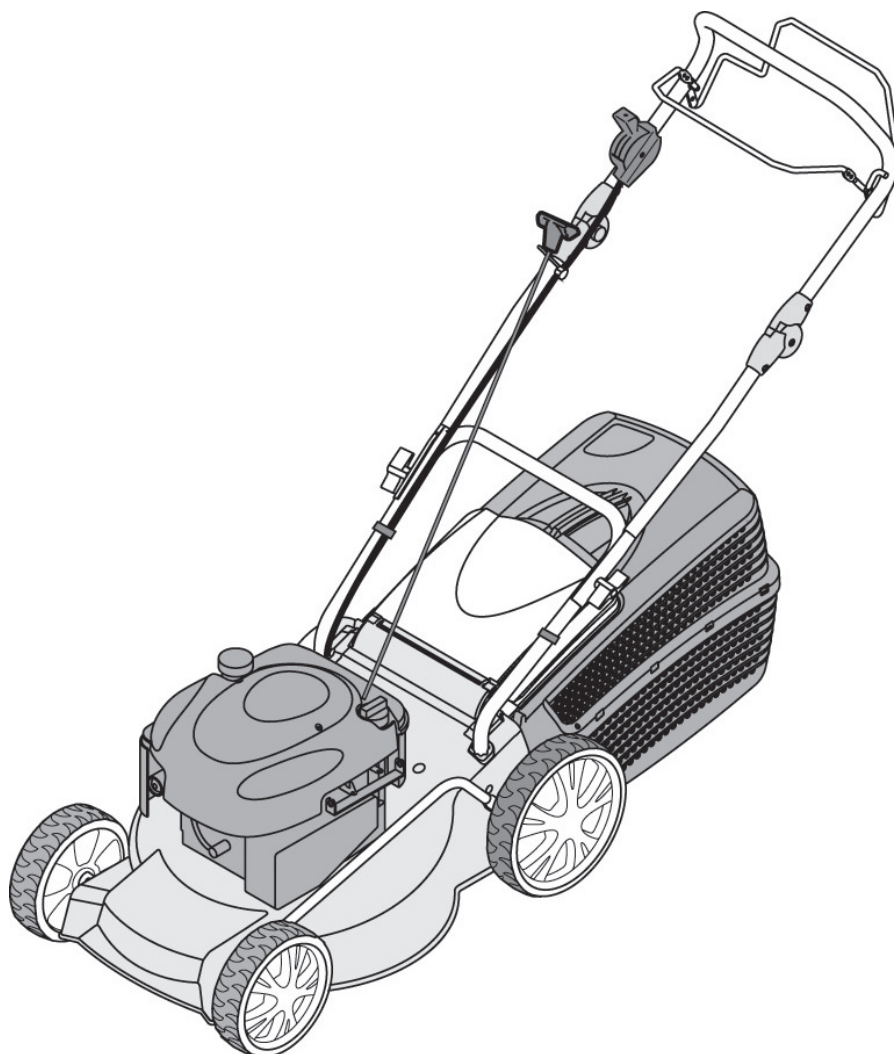

**L-121361**  
a b c d e f  
2011



# 121361

# AL-KO

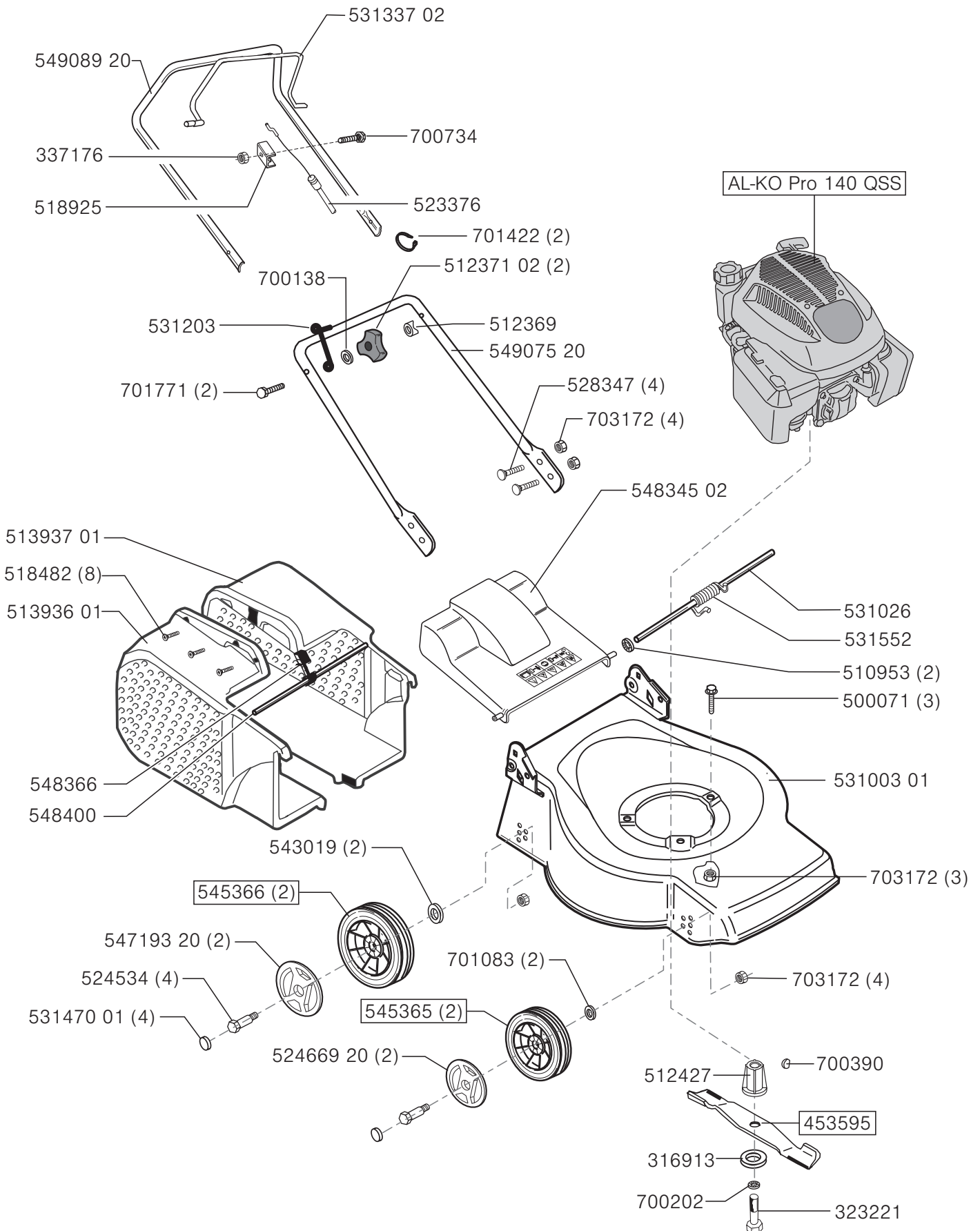

a (GS)	b	c	d	e	f
02/11					



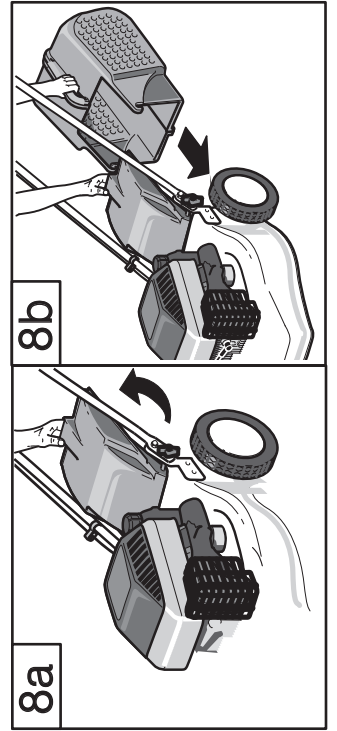
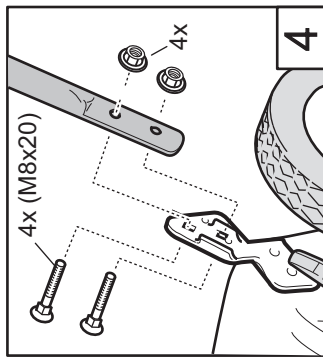
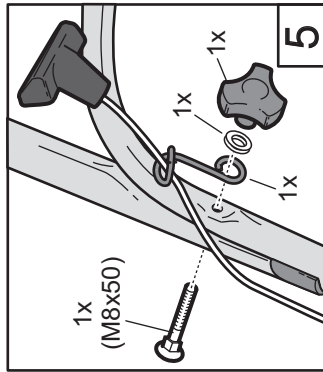
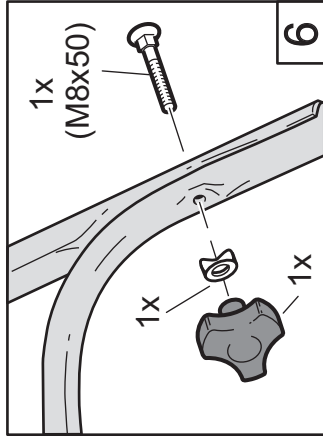
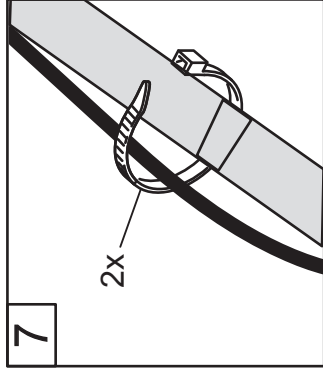
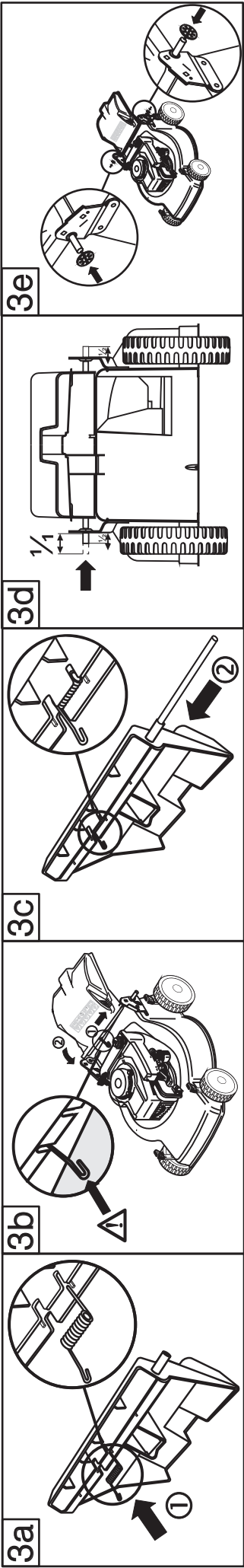

## EG-Konformitätserklärung

**D**

Hiermit erklären wir, dass dieses Produkt, in der von uns in Verkehr gebrachten Ausführung, den Anforderungen der harmonisierten EG-Richtlinien, EG-Sicherheitsstandards und den produktspezifischen Standards entspricht.

**Produkt**  
Benzin-Rasenmäher

**Hersteller**  
AL-KO Kober Srl  
Via Pusteria, 9  
I-39030 Vandoies (BZ)

**Konformitätsbewertung**  
2000/14/EG  
Anhang VIII

**Seriennummer**  
G 1001001

Divisione Garden + Hobby  
Via Como, 71  
I-23883 Brivio (LC)

**Bevollmächtigter**  
Anton Eberle  
Ichenhauser Str. 14  
D-89359 Kötz

**Typ**  
Classic 4.0 B (40 cm)

**EG-Richtlinien**  
98/37/EG (...2009-12-28)  
2006/42/EG (2009-12-29...)  
2002/88/EG  
2004/108/EG  
2000/14/EG

**Harmonisierte Normen**  
EN 836:1997-09  
EN 836/A1:1998-06  
EN 836/A2:2001-10  
EN 836/A3:2004-05  
EN 836/prA4:2009  
ISO 14982

**Schalleistungspegel**  
gemessen / garantiert  
95 / 96 dB(A)

**Benannte Stelle**  
TÜV Industrieservice GmbH  
TÜV Süd Gruppe  
Westendstraße 199  
D-80686 München

Brivio, 28.02.2011



Sergio Tomaciello, Managing Director

## EC Declaration of conformity

**GB**

We hereby declare that this product, in the form in which it is marketed, meets the requirements of the harmonised EU guidelines, EU safety standards, and the product-specific standards.

**Product**  
Petrol lawnmower

**Manufacturer**  
AL-KO Kober Srl  
Via Pusteria, 9  
I-39030 Vandoies (BZ)

**Conformity evaluation**  
2000/14/EG  
Appendix VIII

**Serial number**  
G 1001001

Divisione Garden + Hobby  
Via Como, 71  
I-23883 Brivio (LC)

**Executive Officer**  
Anton Eberle  
Ichenhauser Str. 14  
D-89359 Kötz

**Model**  
Classic 4.0 B (40 cm)

**EU directives**  
98/37/EG (...2009-12-28)  
2006/42/EG (2009-12-29...)  
2002/88/EG  
2004/108/EG  
2000/14/EG

**Harmonised standards**  
EN 836:1997-09  
EN 836/A1:1998-06  
EN 836/A2:2001-10  
EN 836/A3:2004-05  
EN 836/prA4:2009  
ISO 14982

**Sound power level**  
measured / guaranteed  
95 / 96 dB(A)

**Notified body**  
TÜV Industrieservice GmbH  
TÜV Süd Gruppe  
Westendstraße 199  
D-80686 München

Brivio, 28.02.2011



Sergio Tomaciello, Managing Director

## EG-conformiteitsverklaring

**NL**

Hiermee verklaren wij, dat dit product, in de door ons in het verkeer gebrachte uitvoering, voldoet aan de eisen van de geharmoniseerde EU-richtlijnen, EU-veiligheidsnormen en de productspecifieke normen.

**Product**  
Benzinegrasmaaier

**Fabrikant**  
AL-KO Kober Srl  
Via Pusteria, 9  
I-39030 Vandoies (BZ)

**Conformiteitsbeoordeling**  
2000/14/EG  
bijlage VIII

**Serienummer**  
G 1001001

Divisione Garden + Hobby  
Via Como, 71  
I-23883 Brivio (LC)

**Gevolmachtigde**  
Anton Eberle  
Ichenhauser Str. 14  
D-89359 Kötz

**Type**  
Classic 4.0 B (40 cm)

**EU-richtlijnen**  
98/37/EG (...2009-12-28)  
2006/42/EG (2009-12-29...)  
2002/88/EG  
2004/108/EG  
2000/14/EG

**Geharmoniseerde normen**  
EN 836:1997-09  
EN 836/A1:1998-06  
EN 836/A2:2001-10  
EN 836/A3:2004-05  
EN 836/prA4:2009  
ISO 14982

**Geluidsniveau**  
gemeten / gegarandeerd  
95 / 96 dB(A)

**Aangemelde instantie**  
TÜV Industrieservice GmbH  
TÜV Süd Gruppe  
Westendstraße 199  
D-80686 München

Brivio, 28.02.2011



Sergio Tomaciello, Managing Director

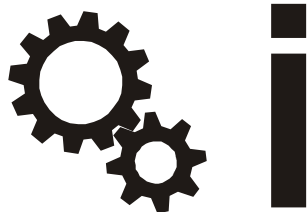



**I** **CAMBIO OLIO**

Raccomandiamo di impiegare l'**AL-KO MOTOR SERVICE KIT Art. 106118** (non incluso nella scatola – richiedetelo al Vostro rivenditore AL-KO di fiducia). Facile cambio dell'olio con siringa di aspirazione, imbuto e contenitore per la raccolta!

**D** **ÖLWECHSEL**

Wir bitten Sie, dass **AL-KO MOTOR SERVICE SET 106118** zu verwenden (nicht im Lieferumfang enthalten – bitte beim AL-KO Händler anfordern). Einfacher Ölwechsel mit Absaugpumpe, Einfülltrichter und Sammelbehälter!

**GB** **CHANGING THE OIL**

We recommend to use the **AL-KO MOTOR SERVICE KIT Art. 106118** (not included into the package – request it to Your AL-KO dealer). Easy change of oil with the aspiration syringe, the funnel and the oil's container!

**F** **CHANGEMENT D'HUILE**

Nous recommandons d'employer **AL-KO MOTOR SERVICE KIT Art. 106118**. (non inclus dans le paquet – demandez-la à le Votre revendeur AL-KO). Facile change d'huile avec seringue d'aspiration, entonnoir et conteneur pour la recueilli!

