

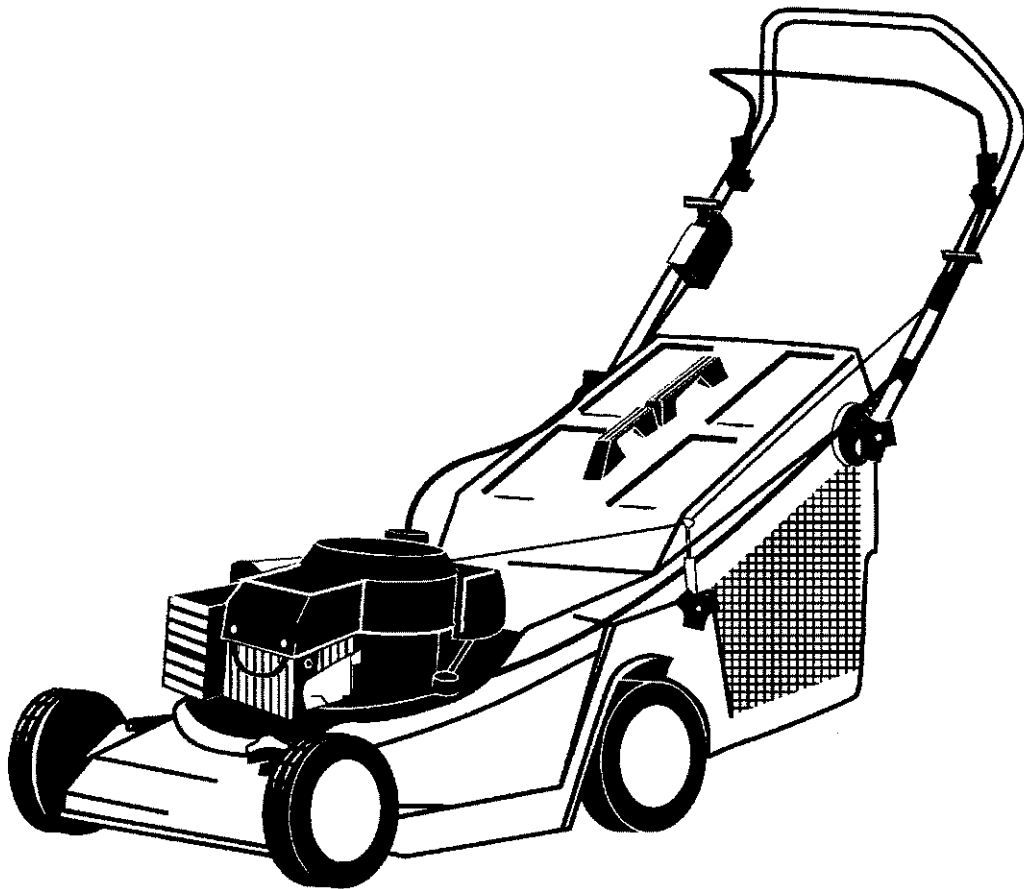

# ALKO

Garden + Hobby



**L-121298**

abc def

2007

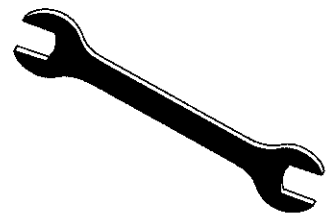

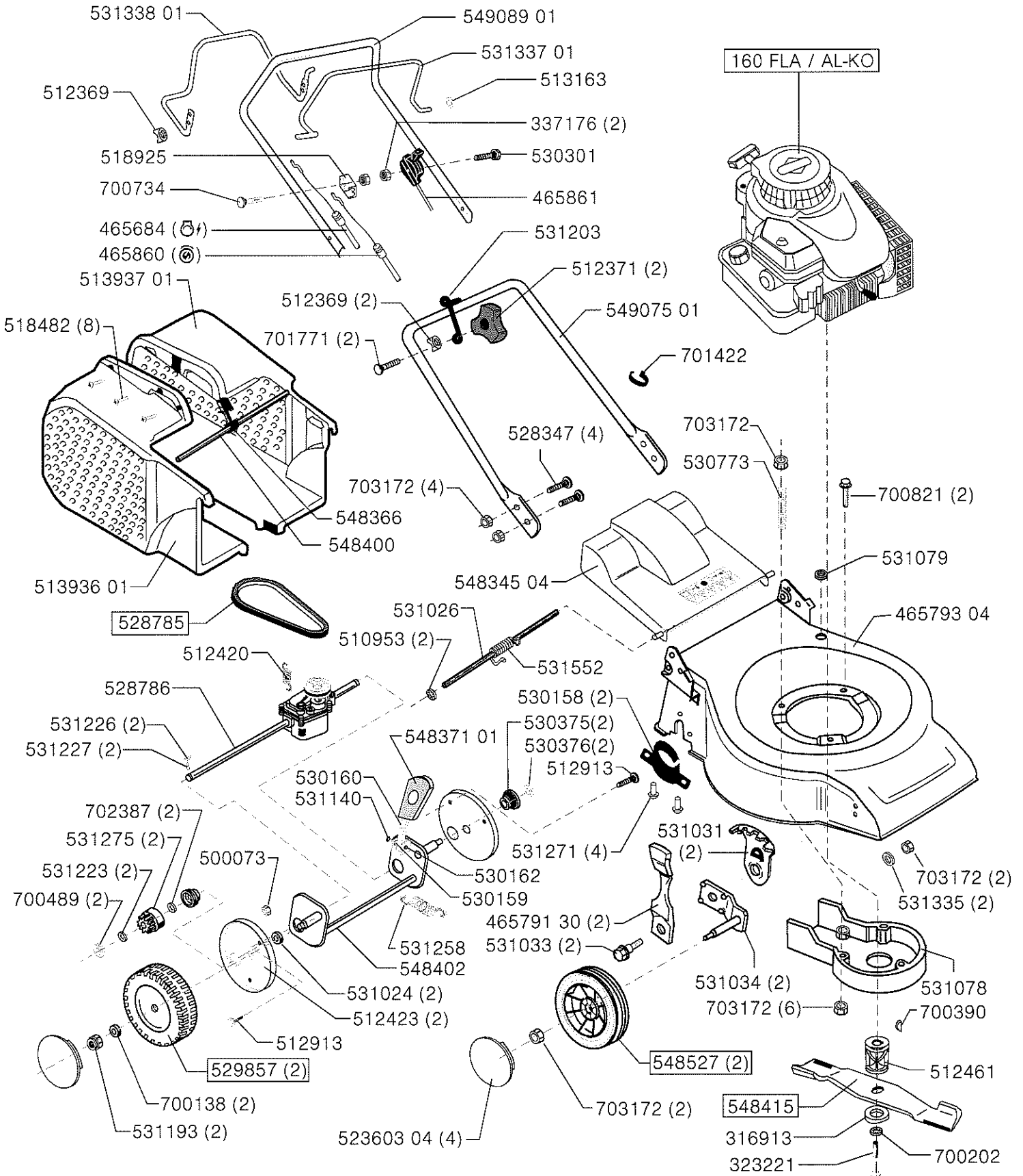

a (BP)	b	c	d	e	f
11/06					

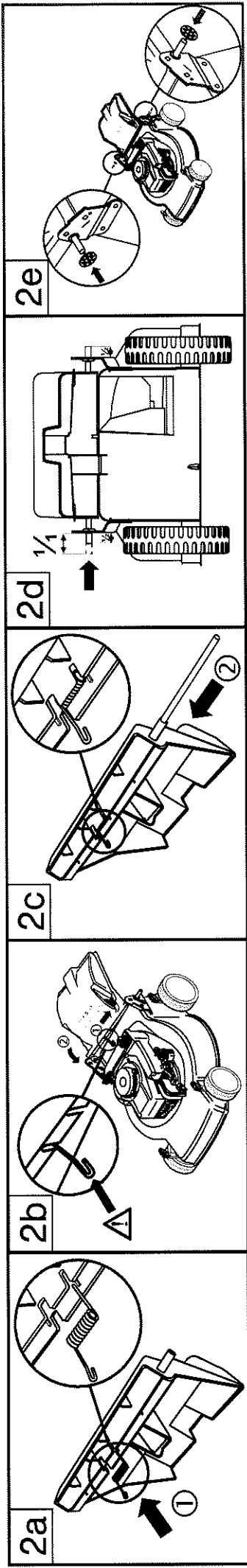
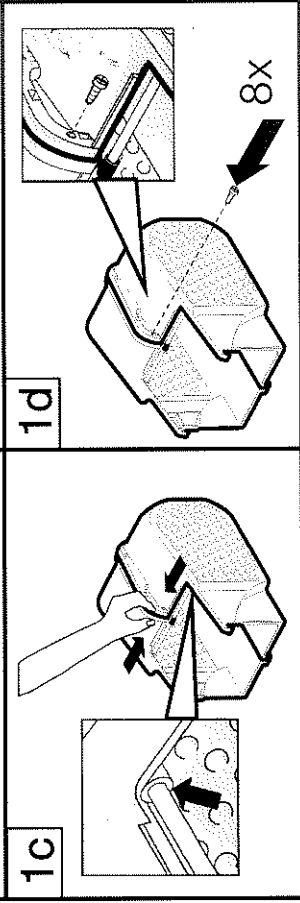
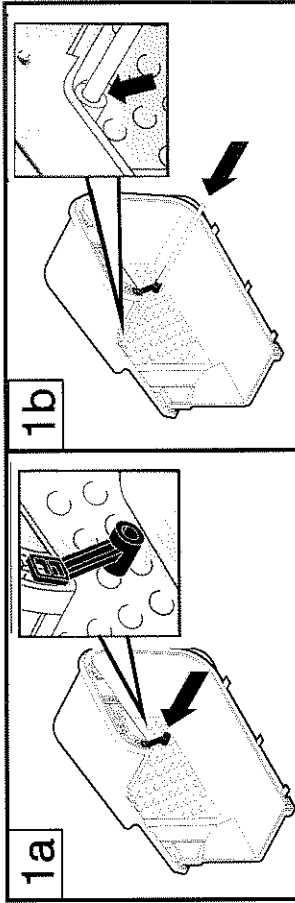
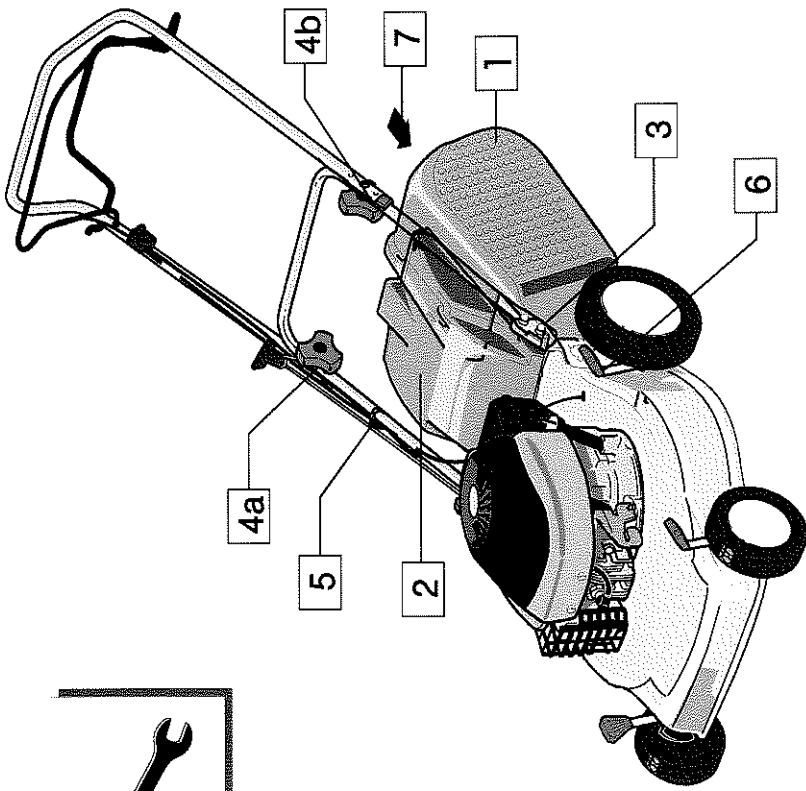
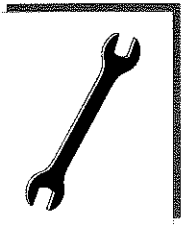

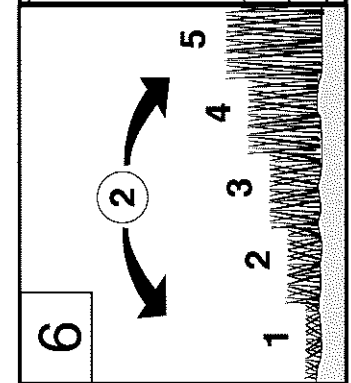
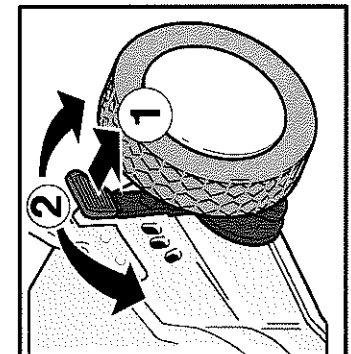
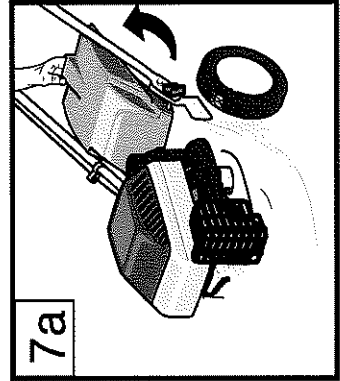
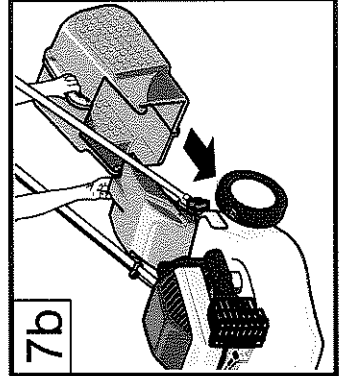
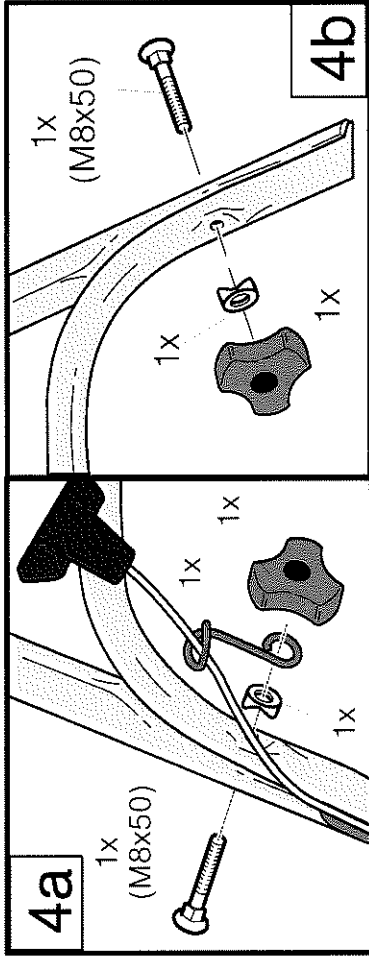
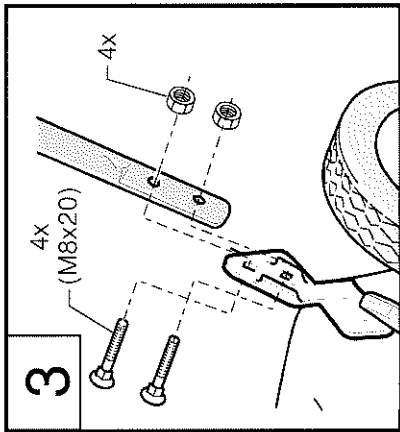
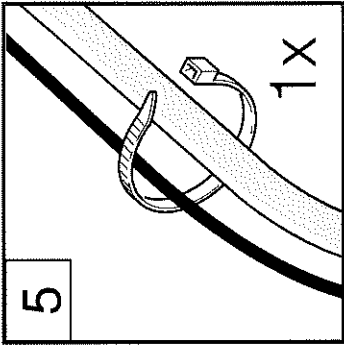

a	(BP)	b	c	d	e	f
---	------	---	---	---	---	---

L121298 02/07



EG-Konformitätserklärung	EC declaration of conformity	Déclaration de conformité CE	EC-verklaring van conformiteit	Dichiarazione di conformità CE	Declaración de conformidad de la CE
Wir	we	Nous	Wij	Noi	Nosotros
<b>AL-KO Kober GmbH, A-8742 Werk Obdach / Steiermark</b>					
erklären, dass die Maschine Rasenmäher, Typen:	declare that the machine lawnmowers, walk behind and mains-operated, Type:	déclarons que la machine Tondeuse à conducteur à pied commandées à la main Type :	verklaren dat de machine Grasmaaijer, Type:	dichiariamo che la macchina Falciatrice, Tipo:	declaramos que la máquina Cortacésped, del tipo:
<b>Classic 51 BR</b>					
mit den folgenden EG-Richtlinien übereinstimmen:	conforms to the specifications of the following EC directives:	est conforme aux spécifications des directives CE suivantes: <b>98/37/ EG • 89/336/EWG • 2000/14/EG</b>	overeenstemt met de volgende CE-richtlijnen:	è conforme alle seguenti direttive CE:	cumple las siguientes directrices de la CE:
gegebenenfalls angewendete Normen:	standards applied, if applicable:	Normes appliquées le cas échéant : <b>EN 836+A1+A2 • EN ISO 14982</b>	toegepaste normen, indien van toepassing	norme eventualmente applicate:	normas eventualmente aplicadas:
<p>Gegebenenfalls Name und Anschrift der Person, die die technischen Unterlagen aufbewahrt/ If applicable, name and address of the person who keeps the technical documentation/ Le cas échéant, nom et adresse de la personne qui conserve la documentation technique/ Indien van toepassing naam en adres van de persoon die de technische documenten bewaart/ Eventualmente nome e indirizzo della persona che conserva la documentazione tecnica/ Eventualmente nombre y dirección de la persona que guarda la documentación técnica:</p> <p><b>AL-KO Geräte GmbH Technische Entwicklung Geräte Ichenhauser Strasse 14 D-89359 Kötz</b></p>					
<p>gewandes Konformitätsbewertungsverfahren/ Conformity assessment procedure applied/ Sovellettu yhdenmukaisuuden toteamismenetelmä/ Procédure appliquée pour l'évaluation de la conformité/ Metodo di valutazione conformità applicato/ Procedimiento aplicado para la evaluación de conformidad.</p>					
<p>Gegebenenfalls Name und Anschrift der beteiligten benannten Stelle/ If applicable, name and address of the notified body involved/ Le cas échéant, nom et adresse de le bureau intéressé/ Tarvittaessa tarkastuspaikan nimi ja osoite/ Indien van toepassing naam en adres van de deelnemende, aangewezen instelling/ Eventualmente nome e indirizzo dell'Ufficio interessato nominato/ Eventualmente nombre y dirección del organismo involucrado e indicado.</p>					
<p>Typen/ Type/ Tipo</p> <p><b>Classic 51 BR</b></p>					
<p>Schnittbreite/ Cutting width/ Largeur de coupe/ Maalbreedte/ Larghezza di taglio/ Ancho de corte</p> <p><b>51 cm</b></p>					
<p>Gemessener Schalleistungspegel/ Measured sound power level/ Niveau de puissance acoustique mesuré/ Gemeten geluidsvermogen/ Livello di pressione acustica misurato/ Nivel de potencia acústica medido</p> <p><b>L<sub>WA</sub></b></p>					
<p>Garantierter Schalleistungspegel/ Guaranteed sound power level/ Niveau de puissance acoustique garanti/ Gegarandeerd geluidsvermogen/ Livello di pressione acustica garantito/ Nivel de potencia acústica garantizado</p> <p><b>98 dB(A)</b></p>					
<p><b>96 dB(A)</b></p>					
<p><b>98 dB(A)</b></p>					

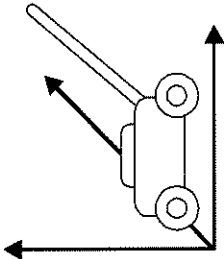
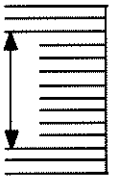

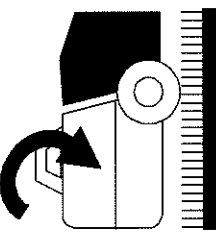
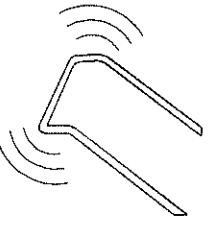
Type:		Classic 51 BR	
	1480 x 1040 x 540		51 cm
	34,00		3 – 8 cm
	65 L.		EN 1033 $a_{vhw} =$ 12 m/s <sup>2</sup>

Ing. Rainer Klaus

Geschäftsleiter / Director / Directeur

Obdach, 22.02.2007  
 Ort/Place / Lieu / Plaats / Località / Localidad / Helyiség / Unterschrift / Signature / Handtekening / Firma / Aláírás / Beauftragter / Representative / Délégue / Gemachtigd / Responsable / Delegado / Misto / Miesto / Miejscowość / Local / Podpis / Assinatura

1) Ilt nur für Rasenmäher, Rasentrimmer und Rasenkantentrimmer / Valid only for Lawnmowers, lawn trimmers and lawn edge trimmers / Être valable pour tondeuse, coupe-gazon et coupe-bordures.  
 2) Angaben zum Unterzeichner, der bevollmächtigt ist, die Erklärung für den Hersteller oder seinen in der Gemeinschaft niedergelassenen Bevollmächtigten rechtsverbindlich zu unterzeichnen.  
 Identification of the person empowered to sign on behalf of the manufacturer or his authorized representative established in the community / Identification du signataire ayant reçu pouvoir pour engager le fabricant ou son mandataire établi dans la communauté.



**I CAMBIO OLIO**

Raccomandiamo di impiegare l'**AL-KO MOTOR SERVICE KIT Art. 106118**  
(non incluso nella scatola – richiedetelo al Vostro rivenditore AL-KO di fiducia).  
Facile cambio dell'olio con siringa di aspirazione, imbuto e contenitore per la raccolta!

**D ÖLWECHSEL**

Wir bitten Sie, dass **AL-KO MOTOR SERVICE SET 106118** zu verwenden  
(nicht im Lieferumfang enthalten – bitte beim AL-KO Händler anfordern).  
Einfacher Ölwechsel mit Absaugpumpe, Einfülltrichter und Sammelbehälter!

**GB CHANGING THE OIL**

We recommend to use the **AL-KO MOTOR SERVICE KIT Art. 106118**  
(not included into the package – request it to Your AL-KO dealer).  
Easy change of oil with the aspiration syringe, the funnel and the oil's container!

**F CHANGEMENT D'HUILE**

Nous recommandons d'employer **AL-KO MOTOR SERVICE KIT Art. 106118**.  
(non inclus dans le paquet – demandez-la à le Votre revendeur AL-KO).  
Facile change d'huile avec seringue d'aspiration, entonnoir et conteneur pour la recueille!



Land	Firma	Tel	Fax
A	AL-KO Kober Ges.m.b.H.	(+43) 3578/2515227	(+43) 3578/251538
AUS	AL-KO International PTY. LTD	(+61) 3/9767-3700	(+61) 3/9767-3799
B	Eurogarden NV	(+32) 16/805427	(+32) 16/805425
CH	AL-KO Kober AG	(+41) 56/4183150	(+41) 56/4183160
CZ	AL-KO Kober Spol.sr.o.	(+420) 382/210381	(+420) 382/212782
D	AL-KO Geräte GmbH	(+49) 8221/203-0	(+49) 8221/203-138
DK	AL-KO Ginge A/S	(+45) 98/82-1000	(+45) 98/82-5454
E	ANMI	(+34) 93/3002618	(+34) 93/3001769
F	AL-KO S.A.S.	(+33) 3/85-763540	(+33) 3/85-763588
GB	Rochford Garden Machinery Ltd.	(+44) 1963/828050	(+44) 1963/828052
H	AL-KO KFT	(+36) 29/537050	(+36) 29/537051
HR	Brun.ko.-prom d.o.o.	(+385) 1 3096 567	(+385) 1 3096 567
I	AL-KO Kober GmbH / SRL	(+39) 039/9 329311	(+39) 039/9329390
LV	AL-KO Kober SIA	(+371) 7/409330	(+371) 7807018
N	AL-KO GINGE A/S	(+47) 64/862550	(+47) 64/862554
NL	Mechatechniek B.V.	(+31) 18/2567824	(+31) 18/2533895
PL	AL-KO Kober z.o.o.	(+48) 61/8161925	(+48) 61/8161980
RO	OMNITECH TRADING SA	(+4) 021 326 36 72	(+4) 021 326 36 79
RUS	OOO AL-KO Kober	(+7) 095/1688716	(+7) 095/1623238
RUS	AL-KO St. Petersburg GmbH	(+7) 812/4461084	(+7) 812/4461084
S	AL-KO Ginge Svenska AB	(+46) 31/573580	(+46) 31/575620
SK	AL-KO Kober Slovakia Spol.s.r.o.	(+421) 2/45994112	(+421) 2/45648117
SLO	SERVIS HUDOBIVNIK	(+386) 4 2046884	(+386) 4 2049730
TR	ZIMAS A.S.	(+90) 232 4580586	(+90) 232 4572697
UA	TOV AL-KO Kober	(+380) 44/4923396	(+380) 44/4923397

Stand 01/2007

AL-KO Geraete GmbH  
Head Quarter  
Ichenhauser Str. 14  
89359 Koetz  
Telefon: (+49)8221/203-0  
Telefax: (+49)8221/203-138  
www.al-ko.com